

The SOLIDWEDGE™ is a breakthrough technology that allows conduction cooled modules to operate at higher thermal loads in higher temperature environments.

## OPTIMIZED FOR VITA 48.2 AND CPCI



**US PATENT**  
**8,456,846**

## POSITIVE RETRACTION

Adjacent wedge segments are connected to prevent a stuck wedge lock. Turning the drive screw counterclockwise retracts the threaded drive wedge, pulling each of the connected segments down to their relaxed position.

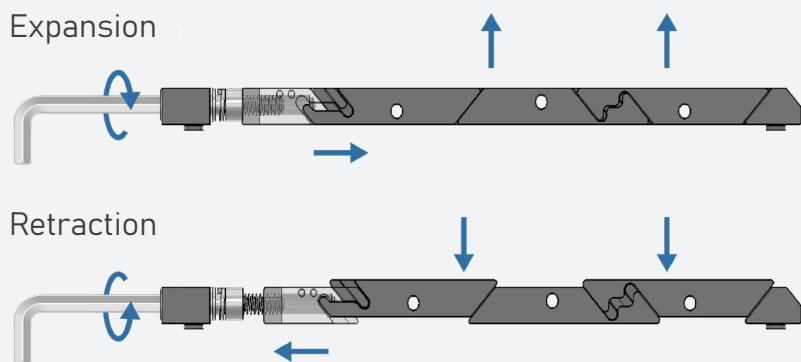

## THERMAL RESISTANCE

0.13 °C/W Resistance per Card Edge

## FEATURES

- 800 lb Clamping Force
- Mass: 19 g
- #8 Drive Screw
- Zero Insertion Force
- Low Profile Design
- Self-Retracting Segments
- Superior Plating Endurance
- Optimized for Vita Specifications
- Models Available for Download
- Torque to 8-15 in-lbs

## MATERIALS

- Active Wedge Segments: 6061-T6511
- Front Mounting Block: 6061-T6511
- Screws, Nuts, Washers:  
300 Series Stainless Steel  
(passivated per AMS - 2700)

## 3D MODEL:

<https://a360.co/3BI7Q7U>

The SOLIDWEDGE™ design provides three times the thermal contact area of conventional wedge locks. The design also features a larger screw size, which creates higher contact forces between the heat frame and cold wall surfaces, significantly improving thermal performance.

The interconnected links of the SOLIDWEDGE™ feature positive retraction of all segments without the use of springs or other mechanisms.

## PART NUMBER BUILDER

Required

Additional Specifications

<b>SW5</b>	<b>455</b>	<b>250</b>	<b>300</b>	<b>XXX</b>	<b>XX</b>	<b>B075</b>	<b>YY</b>	
Wedge:	Spacing: 4.55" MOUNTING HOLE SPACING	Height: 0.250"	Width: 0.300"	Hex:	Finish:	1 Boss Length 0.075"	2	3
SW - SOLIDWEDGE 5 - ACTIVE SEGMENTS		3/32" HEX KEY - [8332] M2.5 HEX KEY - [8M25] 7/64" HEX KEY - [8764]			[BV] - BELLEVILLE WASHERS [NL] - NYLOK LOCK PATCH [HC] - HELICOIL INSERTION			
<ul style="list-style-type: none"> <li>BLACK ANODIZE PER MIL-A-8625, TYPE II, CLASS 2 [BA]</li> <li>HARD BLACK ANODIZE PER MIL-A-8625, TYPE III, CLASS 2 [BH]</li> <li>CHEMICAL FILM PER MIL-C-5541, CLASS 1A, CLEAR [CC]</li> <li>CHEMICAL FILM PER MIL-C-5541, CLASS 1A, GOLD, NON-ROHS [CG]</li> <li>ELECTROLESS NICKEL PER MIL-C-26074, CLASS 4, GRADE B, BRIGHT [EN]</li> </ul>								

RECOMMENDED PART NUMBER: SW5-455-250-300-8332-BA-B075-BV-HC

## MOUNTING DETAILS

UNLESS OTHERWISE SPECIFIED  
DIMENSIONS ARE IN INCHES.  
TOLERANCES:  
TWO PLACE DECIMAL: ±.01  
THREE PLACE DECIMAL: ±.005

