

The SOLIDWEDGE™ is a breakthrough technology that allows conduction cooled modules to operate at higher thermal loads in higher temperature environments.

OPTIMIZED FOR VITA 48.2 AND CPCI



US PATENT
8,456,846

POSITIVE RETRACTION

Adjacent wedge segments are connected to prevent a stuck wedge lock. Turning the drive screw counterclockwise retracts the threaded drive wedge, pulling each of the connected segments down to their relaxed position.

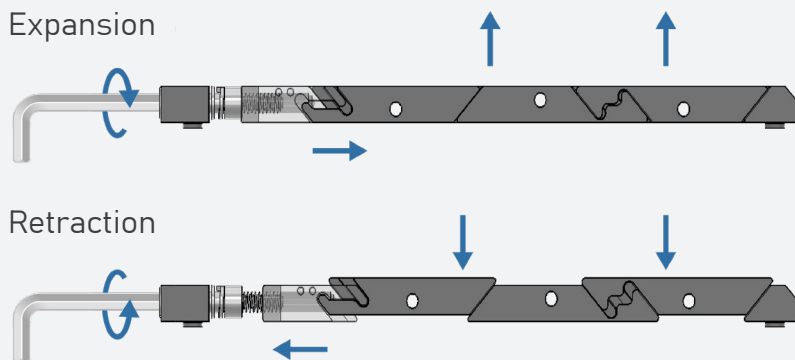

SW5 Pictured

THERMAL RESISTANCE

0.11 °C/W Resistance per Card Edge

FEATURES

- 800 lb Clamping Force
- Mass: 18 g
- #6 Drive Screw
- Zero Insertion Force
- Low Profile Design
- Self-Retracting Segments
- Superior Plating Endurance
- Optimized for VITA Specifications
- Models Available for Download
- Torque to 6-10 in-lbs

MATERIALS

Active Wedge Segments: 6061-T6511

Front Mounting Block: 7075-T7351

Screws, Nuts, Washers:
300 Series Stainless Steel
(passivated per AMS - 2700)

3D MODEL:

<https://a360.co/4vFUEwU>

The SOLIDWEDGE™ design provides three times the thermal contact area of conventional wedge locks. The design also features a larger screw size, which creates higher contact forces between the heat frame and cold wall surfaces, significantly improving thermal performance.

The interconnected links of the SOLIDWEDGE™ feature positive retraction of all segments without the use of springs or other mechanisms.

PART NUMBER BUILDER

Required

Additional Specifications

SW5	64	225	225	XXX	XX	B075	YY	
Wedge:	Spacing: 6.4" MOUNTING HOLE SPACING	Height: 0.225"	Width: 0.225"	Hex:	Finish:	1 BOSS LENGTH 0.075"	2	3
SW - SOLIDWEDGE 5 - ACTIVE SEGMENTS		3/32" HEX KEY - [332] M2.5 HEX KEY - [M25] 7/64" HEX KEY - [764]			[BV] - BELLEVILLE WASHERS [NL] - NYLOK LOCK PATCH [HC] - HELICOIL INSERTION			
		BLACK ANODIZE PER MIL-A-8625, TYPE II, CLASS 2 [BA] HARD BLACK ANODIZE PER MIL-A-8625, TYPE III, CLASS 2 [BH] CHEMICAL FILM CLEAR [CC] CHEMICAL FILM GOLD [CG] ELECTROLESS NICKEL [EN]		See last page for more plating info				

RECOMMENDED PART NUMBER: SW5-64-225-225-332-BA-B075-BV-HC

MOUNTING DETAILS

UNLESS OTHERWISE SPECIFIED
DIMENSIONS ARE IN INCHES.
TOLERANCES:
TWO PLACE DECIMAL: ±.01
THREE PLACE DECIMAL: ±.005

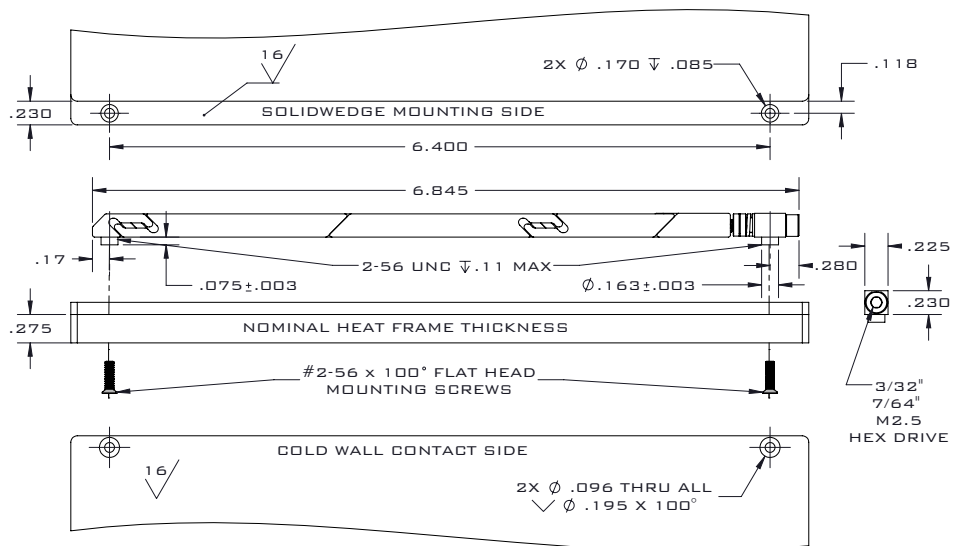
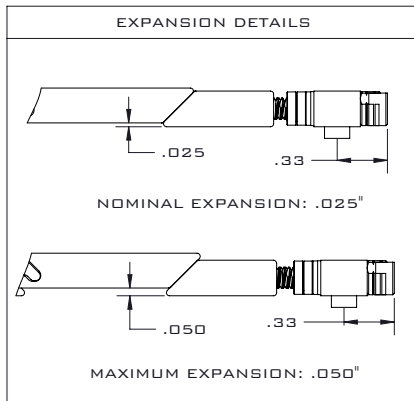

Standard material specs for WaveTherm's SOLIDWEDGE™, injector/ejectors, and OpenCOTS products.

ASSEMBLY HARDWARE



300 SERIES STAINLESS STEEL

Compliance	Specification	Use Case
✓ DFARS	Passivated per	Standard material for screws, nuts, washers, and SOLIDWEDGE™ straps in WaveTherm product assemblies.
✓ RoHS	AMS-2700	
✓ REACH		

ALUMINUM PLATING



BLACK ANODIZED - BA

Compliance	Specification	Properties and Use Case
✓ RoHS	MIL-A-8625	Provides reliable corrosion resistance and durability. Ideal for use in demanding applications requiring high insertion/extraction counts.
✓ REACH	Type II	
	Class 2	



BLACK ANODIZED HARDENED - BH

Compliance	Specification	Properties and Use Case
✓ RoHS	MIL-A-8625	Provides superior corrosion resistance and high durability. Ideal for use in harsh and rugged environments with high insertion/extraction counts.
✓ REACH	Type III	
	Class 2	



CHEMICAL FILM CLEAR - CC

Compliance	Specification	Properties and Use Case
✓ RoHS	MIL-DTL-5541	Provides good corrosion resistance and electrical conductivity with lower durability. Not ideal for high insertion/extraction counts.
✓ REACH	Type II	
	Class 1A Clear	



CHEMICAL FILM GOLD - CG

Compliance	Specification	Properties and Use Case
✗ RoHS	MIL-DTL-5541	Provides good electrical conductivity with lower durability. Not suited for high insertion/extraction counts.
✗ REACH	Type I	
	Class 1A Gold	



ELECTROLESS NICKEL - EN

Compliance	Specification	Properties and Use Case
✓ RoHS	MIL-C-26074	Provides excellent thermal performance and excellent electrical conductivity. Ideal for high-performance thermal management.
✓ REACH	Class 4	
	Grade B	

*varies based on plating vendor's certificates of conformance

SOLIDWEDGE™ INSTALLATION

1

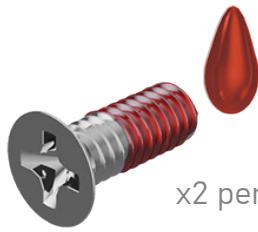

x2 per SOLIDWEDGE

Apply Loctite 2760 to #2-56-100° flat head mounting screws (not included)

2

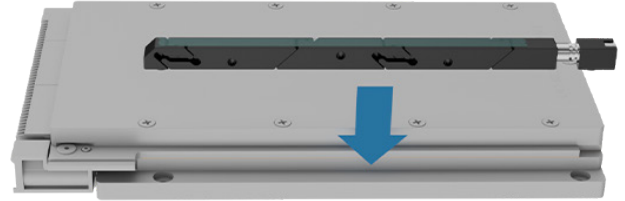

Align SOLIDWEDGE to mounting hole locations

3



Install screws and torque to 2 in-lbs. Ensure mounting screw doesn't hit drive screw.
(reference mounting drawing for max thread engagement)

4

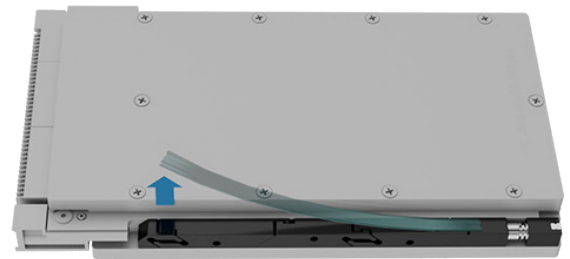

Remove mounting tape from SOLIDWEDGE

CHECK INSTALL

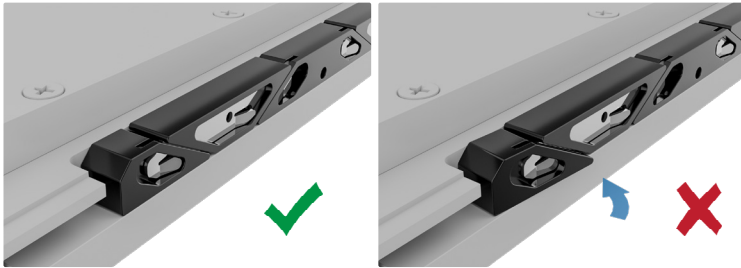

Check alignment on both mounting blocks after torquing and press to straighten if necessary.

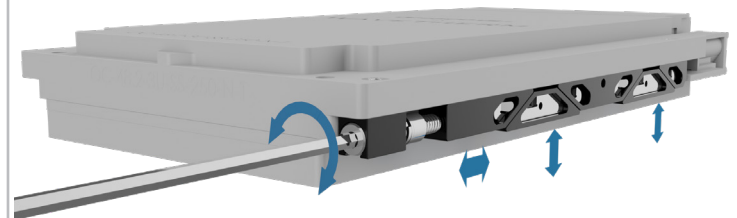

Ensure SOLIDWEDGE is functioning correctly by expanding and contracting with a hex key.

WARNING:



SOLIDWEDGES are not intended to be mounted directly to PCBs. The opposing force of the mounting blocks may result in board damage.